

REV.	ECN.NO.	MODIFY.CONTENT	DATE
A		NEW	2019/10/29

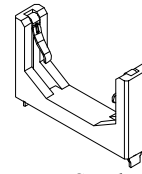

3D View, Scale=2:1

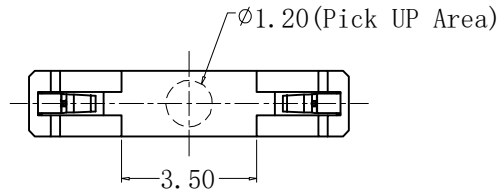
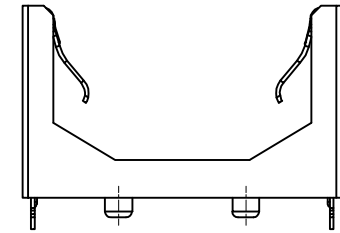

有柱规格

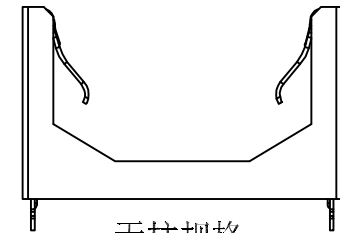
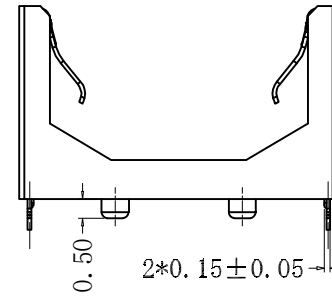
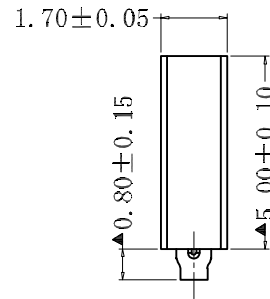
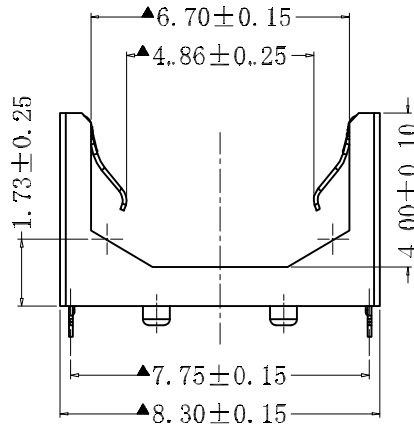

无柱规格

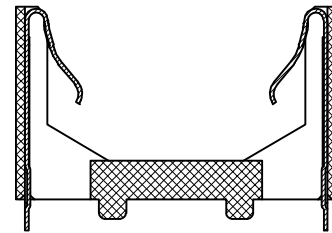
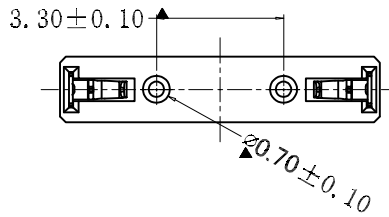

SPECIFICATION:

1. Mechanical:

- 1.1. Mating force: 10Nf Max. ;
- 1.2. Unmating force: 0~3Nf;
- 1.3. Durability: 3000Cycles;

2. Electrical:

- 2.1. Current Rating: 1.0A Max. ;
- 2.2. Voltage Rating: 5V Max. ;
- 2.3. Dielectric Withstanding volage: 100VAc;
- 2.4. Contact resistance: 50m Ohms Max. ;
- 2.5. Insulation Resistance: 100M Ohms Min. ;

3. Environmental:

- 3.1. Operating temperature: -25° C~+85° C;
- 3.2. Wetting Temperature: 265 ± 5° C, 5 ± 0.5s

NO.	PN.	DESCRIPTION
1	JYS-BY500-242	塑胶有柱LCP黑色, 端子1u"
2	JYS-BY500-243	塑胶有柱LCP白色, 端子1u"
3	JYS-BY500-244	塑胶有柱LCP黑色, 端子3u"
4	JYS-BY500-245	塑胶有柱LCP白色, 端子3u"
5	JYS-BY500-246	塑胶无柱LCP黑色, 端子1u"
6	JYS-BY500-247	塑胶无柱LCP白色, 端子1u"
7	JYS-BY500-248	塑胶无柱LCP黑色, 端子3u"
8	JYS-BY500-249	塑胶无柱LCP白色, 端子3u"

GENERAL TOLERANCE		DWG NO.	JYA1018-01	APPD:	WND	Scale	1:1
X.±0.45	x.±5°	Title	Ear Phone Battery 2PIN 立式 5.0H	CHKD:	DR:	UNIT	mm
.X±0.35	.x±2°						
.XX±0.25	.xx±1°	Part NO.	SEE TABLE	Date	2019/10/29		
.XXX±0.15	.xxx±0.5°						
SHEET	1/2						

JYSCONN Shenzhen
JYSCONN Electronics Co., LTD.

REV.	ECN.NO.	MODIFY.CONTENT	DATE
A		NEW	2019/10/29

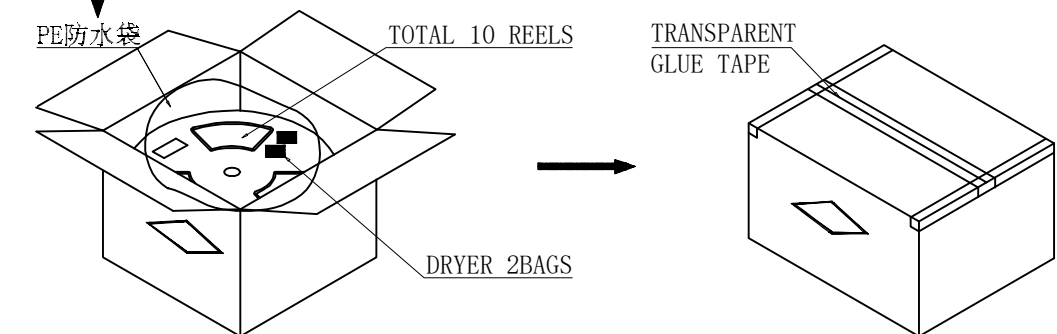
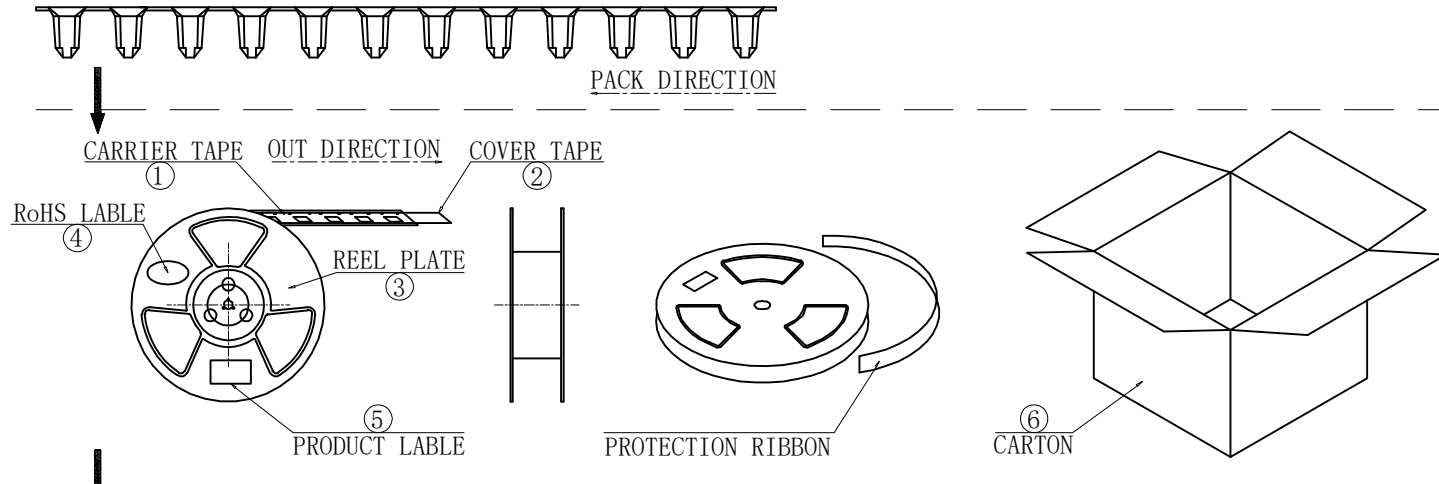
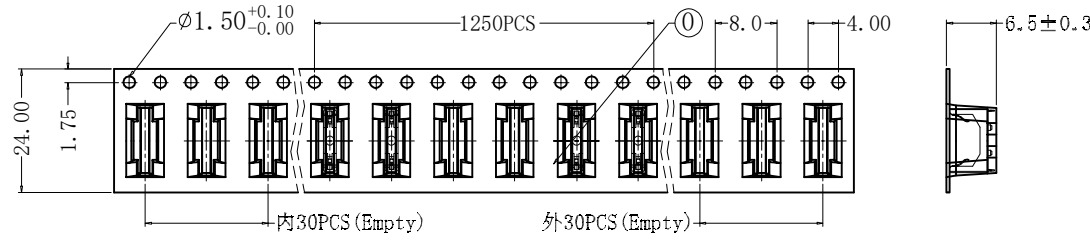

说明:

1. 每卷前后各空30PCS, 尾部用美纹胶纸封住;
2. 将产品放满盘后, 再卷一圈保护带, 用美纹胶纸将其封住, 并贴上1Pcs物料标签;
3. 每18卷盘一叠共22500Pcs装入1个外箱内;
4. 在搬运过程中要轻拿轻放;
5. 在运输中不可堆放过多(1.8M最高), 不可重压;
6. 跌落测试条件:
成品箱从1.2米高度自由落体(一角三棱六面):
a. 产品不可跑出下带凹槽;
b. 产品不可有摔伤, 变形;
c. 内包装材料不可严重破损.

NO.	NAME	SPEC	Q' TY
0	BATTERY CONNECTOR		22500PCS/CARTON
1	CARRIER TAPE	W=16mm, T=0.40mm	1250PCS/REEL
2	COVER TAPE	W=13.3mm, T=0.05mm	18PLATES/CARTON
3	REEL PLATE	ϕ 330*100*16.5mm	18PCS/CARTON
4	RoHS LABEL		18PCS/CARTON
5	PRODUCT LABEL		18PCS/CARTON
6	CARTON	340*340*325mm	1PCS/PACKAGE

GENERAL TOLERANCE		DWG NO.	JYSA1018-01	APPD:	WND	Scale	1:1
X.±0.45	x.±5°	Title	Ear Phone Battery 2PIN 立式 5.0H	CHKD:		UNIT	mm
.X±0.35	.x'±2°			DR:			
.XX±0.25	.xx'±1°	Part NO.	包装图	Date	2019/10/29		
.XXX±0.15	.xxx'±0.5°						
SHEET	2/2	Shenzhen JYSCONN Electronics Co., LTD.					